

This article was downloaded by:

On: 26 January 2011

Access details: *Access Details: Free Access*

Publisher *Taylor & Francis*

Informa Ltd Registered in England and Wales Registered Number: 1072954 Registered office: Mortimer House, 37-41 Mortimer Street, London W1T 3JH, UK



## Liquid Crystals

Publication details, including instructions for authors and subscription information:

<http://www.informaworld.com/smpp/title~content=t713926090>

### The mesomorphic behaviour of cyanopropylalkyldimethylammonium bromides

M. Arkas<sup>a</sup>; K. Yannakopoulou<sup>a</sup>; C. M. Paleos<sup>a</sup>; P. Weber<sup>b</sup>; A. Skoulios<sup>b</sup>

<sup>a</sup> NRC 'Demokritos', 15310 Aghia Paraskevi, Attiki, Greece <sup>b</sup> Groupes des Matériaux Organiques, Institut de Physique et Chimie des Matériaux, UMR 0046 (CNRS-ULP-EHICS), Strasbourg Cedex, France

**To cite this Article** Arkas, M. , Yannakopoulou, K. , Paleos, C. M. , Weber, P. and Skoulios, A.(1995) 'The mesomorphic behaviour of cyanopropylalkyldimethylammonium bromides', *Liquid Crystals*, 18: 4, 563 — 569

**To link to this Article:** DOI: 10.1080/02678299508036659

**URL:** <http://dx.doi.org/10.1080/02678299508036659>

PLEASE SCROLL DOWN FOR ARTICLE

Full terms and conditions of use: <http://www.informaworld.com/terms-and-conditions-of-access.pdf>

This article may be used for research, teaching and private study purposes. Any substantial or systematic reproduction, re-distribution, re-selling, loan or sub-licensing, systematic supply or distribution in any form to anyone is expressly forbidden.

The publisher does not give any warranty express or implied or make any representation that the contents will be complete or accurate or up to date. The accuracy of any instructions, formulae and drug doses should be independently verified with primary sources. The publisher shall not be liable for any loss, actions, claims, proceedings, demand or costs or damages whatsoever or howsoever caused arising directly or indirectly in connection with or arising out of the use of this material.

# The mesomorphic behaviour of cyanopropylalkyldimethylammonium bromides

by M. ARKAS, K. YANNAKOPOULOU and C. M. PALEOS  
NRC 'Demokritos', 15310 Aghia Paraskevi, Attiki, Greece

P. WEBER and A. SKOULIOS\*

Groupes des Matériaux Organiques, Institut de Physique et Chimie des Matériaux,  
UMR 0046 (CNRS-ULP-EHICS), 23, rue du Loess,  
67037 Strasbourg Cedex, France

(Received 26 June 1994; accepted 31 August 1994)

A homologous series of *N*-cyanopropyl-*N*-alkyl-*N,N*-dimethylammonium bromides was synthesized and characterized. Its thermotropic liquid crystalline behaviour was studied by differential scanning calorimetry, polarizing optical microscopy, dilatometry, and X-ray diffraction. A smectic A mesophase was thus identified. The smectic layers were found to be formed of two ionic planes alternately separated by sub-layers of disordered alkyl chains and cyanopropyl groups. The smectic structure was compared with that of the crystal at room temperature and also that of the smectic T structure of the *N,N*-dialkyl-*N,N*-dimethylammonium bromides already described in the literature.

## 1. Introduction

In a recent paper [1], the liquid crystalline behaviour of a homologous series of dialkyldimethylammonium bromides,  $RR'Me_2N^{\oplus} Br^{\ominus}$ , with alkyl chains in the range from *n*-dodecyl to *n*-octadecyl, was studied using X-ray diffraction. A novel smectic mesophase with two-dimensional tetragonal symmetry was identified, in which the ammonium and bromide ions are orderly arranged in single layers, according to a two-dimensional square lattice. In close contact with one another, the positive and negative ions are alternately placed at the vertices and centres of the square cells so as best to satisfy the coulombic interactions. The parallel and equidistant ionic planes are separated by the alkyl chains with a disordered conformation. From the collected experimental data it could not be decided, however, whether the two alkyl chains of each molecule sit on only one side or on both sides of the ionic layers.

In other connections, mesogenic molecules containing properly selected groups have come to attract increasing attention in recent years. In certain cases, they offer the possibility of promoting designed intermolecular interactions and supramolecular associations and, therefore, of inducing defined liquid crystalline structures and favouring the development of desired (ferroelectric, non-linear optical) physical properties. Incidentally, strong interac-

tions, such as hydrogen bonding, have proved useful also in creating mesogenic complexes from molecules that are fundamentally non-mesogenic in nature [2].

With four distinct branches in their molecules, quaternary ammonium salts [3–5] offer a possibility of combining a variety of functional groups, easily introduced by one-step chemical reactions. We thus thought it of interest to study dialkyldimethylammonium salts in which one of the alkyl chains carries a terminal cyano group. In this work we focused our attention particularly on the series of cyanopropyl(alkyldimethylammonium) bromides ( $N\equiv NC-C_3-C_n-DMABr$ ), in the range  $n = 12$  to 22:

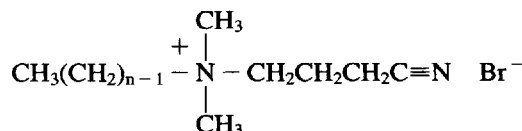

The objective was to force the molecules physically to dimerize and so to force the two alkyl chains of each molecule to extend on both sides of the ionic layers. As seen previously, with a set of 4-cyanoalkoxybenzylidene-4'-alkylanilines [6], cyano groups attached to the extremities of aliphatic chains show indeed a strong tendency to associate antiparallel, in pairs.

\* Author for correspondence.

## 2. Materials

The  $\text{N}\equiv\text{C}-\text{C}_3-\text{C}_n-\text{DMABr}$  compounds studied were prepared using quaternization reactions analogous to those described by Goerdler [7]:

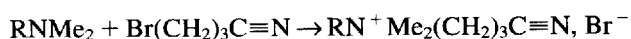

Alkyldimethylamines in the range  $n = 12$  to 18 were obtained from Hoechst; amines with  $n = 20$  and 22 were synthesized by reacting for several days dimethylamine dissolved in alcohol with the corresponding alkyl bromide, in the presence of an excess of sodium carbonate. Bromobutyronitrile was obtained from Aldrich.

In ethyl acetate used as a solvent, 0.01 mol of  $n$ -alkyldimethylamine was added to 0.011 mol of bromobutyronitrile, and the quaternization reaction was conducted at room temperature for several hours. The pale yellow crude material which precipitated was recrystallized twice from ethyl acetate (eventually adding ethanol to enhance solubility); crystallization was induced by cooling to room temperature.

The purity of the resulting compounds was checked by elemental analysis (see table 1). Results were found to be satisfactory for all the compounds in the range  $12 \leq n \leq 18$ . For compounds with  $n = 20$  and 22, the bromide content proved to be smaller than expected (better seen in figure 1), probably due to the unsatisfactory purity of the alkyldimethylamines used. It is important to note that compound  $n = 12$  is hygroscopic, demanding special care in handling.

The chemical structure of the quaternary salts synthesized was checked by proton NMR (AC 250 Bruker NMR Spectrometer operating at 215.13 MHz). The assignment of the peaks was based on intensities. Thus, for  $\text{N}\equiv\text{C}-\text{C}_3-\text{C}_{12}-\text{DMABr}$ , the chemical shifts in  $\text{CD}_3\text{Cl}$  referred to external TMS were:  $\text{CH}_3$  (0.81 ppm) (t),  $\text{CH}_2$  of the main alkyl chain (1.22 ppm) (m),  $\beta\text{-CH}_2$  of the main alkyl chain (1.68 ppm) (m),  $\beta\text{-CH}_2$  of the cyanopropyl chain (2.21 ppm) (t),  $\text{CH}_2\text{CN}$  (2.68 ppm) (t),  $\text{CH}_3\text{N}$  (3.33 ppm) (s),  $\alpha\text{-CH}_2$  of the main alkyl chain (3.43 ppm) (m), and finally  $\alpha\text{-CH}_2$  of the cyanopropyl chain (3.76 ppm) (m). The identity of the peaks  $\alpha$  and  $\beta$  relative to CN was verified by homo-decoupling experiments.

On heating, the compounds start to degrade thermally above temperatures of the order of 200°C. Their thermal stability was assessed by thermogravimetry using a Mettler TC10A instrument coupled with a TA processor and a Mettler M3 balance. Experiments, performed at constant temperature as a function of time, showed the samples to withstand prolonged heating at 150°C with weight losses smaller than a few per cent. This result ensured that the compounds investigated would be unaffected during the thermal studies planned in this work.

Table 1. Elemental analysis of  $\text{N}\equiv\text{C}-\text{C}_3-\text{C}_n-\text{DMABr}$  (calculated values in parenthesis) in per cent.

$n$	C	H	N	Br
12	59.53 (59.82)	10.46 (10.32)	7.58 (7.75)	21.52 (22.11)
14	61.60 (61.68)	10.78 (10.61)	7.03 (7.19)	20.23 (20.52)
16	63.31 (63.29)	11.05 (10.86)	6.47 (6.71)	18.47 (19.14)
18	64.62 (64.70)	11.11 (11.08)	6.16 (6.29)	17.55 (17.93)
20	65.33 (66.05)	11.30 (11.31)	5.68 (5.93)	15.61 (16.71)
22	71.15 (67.15)	12.50 (11.48)	4.64 (5.60)	10.90 (15.77)

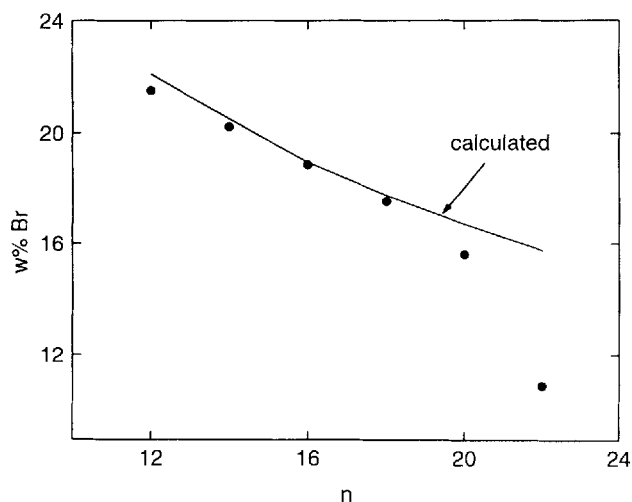

Figure 1. Bromide content of the compounds  $\text{N}\equiv\text{C}-\text{C}_3-\text{C}_n-\text{DMABr}$  as a function of number of carbon atoms ( $n$ ) in the alkyl chains.

## 3. Thermotropic polymorphism

The thermotropic phase behaviour of the compounds synthesized was studied by differential scanning calorimetry (Perkin-Elmer DSC 7, heating and cooling rates of  $10^\circ\text{C min}^{-1}$ ) and polarizing optical microscopy (Leitz Orthoplan, Mettler FP 82 hot stage). DSC thermograms, registered upon heating and subsequent cooling between 0 and 150°C, showed the presence of a sharp peak on heating indicative of a first order phase transition. The fluidity of the samples above the transition temperature and their optical textures (oily streaks and small spherulitic focal-conic domains) suggest the presence of a liquid crystalline phase, smectic A in nature. On cooling, the transition from the smectic to the crystalline state always proceeds with hysteresis, as is usual in connection with the nucleation period of crystallization. The transition from the smectic to the isotropic liquid state could not be investigated within the temperature range scanned which was intentionally restricted to moderate values in order to avoid thermal degradation. The experimental observations are summarized in table 2. It is of interest to note that the transition temperature from the crystal to the smectic mesophase increases with the length of the alkyl chains,

Table 2. Transition temperatures and enthalpies upon heating (values concerning compounds  $n = 20$  and  $22$  are only indicative).

$n$	$T/^\circ\text{C}$	$\Delta H/\text{kJ mol}^{-1}$
12	49	40
14	72	50
16	78	62
18	80	66
20	(86)	(58)
22	(86)	(65)

levelling off at about  $80^\circ\text{C}$  for chains longer than tetradecyl. This means that the lamellar structure of the crystal is essentially determined by the packing of the alkyl chains.

In the particular case of  $\text{N}\equiv\text{C}-\text{C}_3-\text{C}_{18}-\text{DMABr}$ , dilatometry was used to provide further information about the thermal behaviour of the compound and, more interestingly, to establish the value and the temperature dependence of its specific volume. Measurements were performed with a home-made dilatometer [8]. The change in volume was investigated as a function of temperature, upon stepwise heating (steps of  $0.2^\circ\text{C}$  every minute) in the temperature range between  $60^\circ\text{C}$  and  $100^\circ\text{C}$ . For the volume measurements to be meaningful the sample was first carefully degassed (several heating and cooling cycles under vacuum from the low-temperature crystal to the high-temperature fluid liquid crystal). As seen in figure 2, the specific volume increases as a function of temperature, with a sudden jump of  $0.076\text{ cm}^3\text{ g}^{-1}$  at the transition from the crystal to the smectic phase, evidently related to the disordering of the paraffin chains. A least-squares linear fit of the data leads to the following equations for the

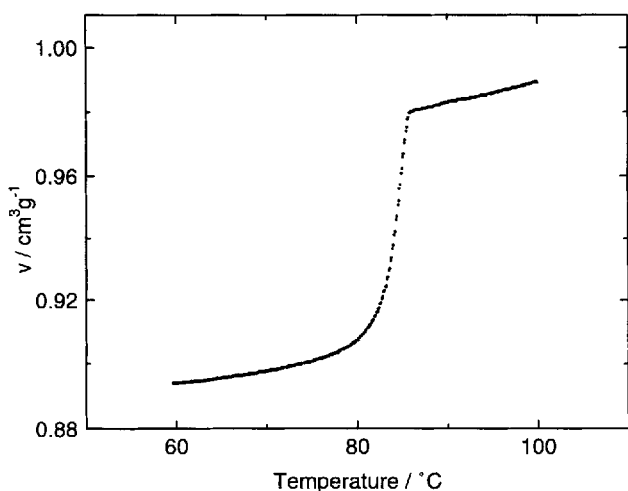

Figure 2. Specific volume of  $\text{N}\equiv\text{C}-\text{C}_3-\text{C}_{18}-\text{DMABr}$  measured by dilatometry upon heating.

temperature dependence of the specific volume of the crystal and the liquid crystal respectively

$$v(\text{cm}^3\text{ g}^{-1}) = 0.872 + 0.00036 T(^\circ\text{C})$$

$$v(\text{cm}^3\text{ g}^{-1}) = 0.926 + 0.00064 T(^\circ\text{C})$$

#### 4. Crystal structure

The crystalline nature of the compounds  $\text{N}\equiv\text{C}-\text{C}_3-\text{C}_n-\text{DMABr}$  at low temperature and the basic features of their structure were studied by X-ray diffraction. Two Guinier focusing cameras (bent-quartz monochromator,  $\text{CuK}\alpha_1$  radiation) were used. One, equipped with a home-made electrical oven, allowed us to register the diffraction patterns photographically. The other, equipped with an Instec hot stage and an Inel curved position-sensitive detector (controlled by a multi-channel analyser) permitted measurement of both the angular position and the intensity of the Bragg reflections.

The diffraction patterns recorded contain a number of Bragg reflections located both at small and wide angles (see figure 3); all are very sharp and perfectly consistent with the existence of well-developed three-dimensional crystals. The reciprocal spacings of the small-angle reflections are in the ratio 1:2:3:4:5, indicating a lamellar structure. The intensities of the successive Bragg harmonics and the lamellar periods measured at  $30^\circ\text{C}$  are given in table 3 and figure 4.

Independent of temperature within experimental accuracy, the lamellar periods measured are very close (within less than  $\sim 2\text{ \AA}$ ) to the length of the molecules in a fully extended zigzag conformation [9]. The molecular packing in the crystal seems therefore to correspond to single layers of straight, upright alkyl chains, set side by

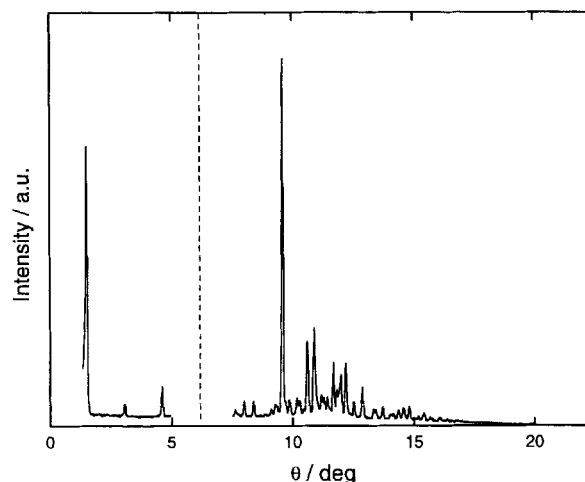

Figure 3. X-ray powder diffraction pattern of  $\text{N}\equiv\text{C}-\text{C}_3-\text{C}_{14}-\text{DMABr}$  in the crystalline state, recorded at  $30^\circ\text{C}$  with a curved position-sensitive detector as a function of the Bragg angle  $\theta$  ( $2d \sin \theta = n\lambda$ ). For clarity, small and wide-angle regions are represented separately.

Table 3. Intensity  $I$  of Bragg reflections and stacking period  $d$  of lamellar crystal (values correspond to peak heights measured for a constant exposure time of 30 min; samples were contained in Lindemann capillaries).

$n$	$d/\text{\AA}$	$I(001)$	$I(002)$	$I(003)$	$I(004)$	$I(005)$
12	25.9	2192	—	456	433	233
14	28.6	3221	273	395	405	273
16	31.2	4062	513	297	484	223
18	34.0	1382	281	—	295	229
20	36.4	2813	803	—	419	403
22	40.2	2414	556	—	350	437

side (see figure 5, left), with the cyanopropyl(dimethylammonium) bromide moieties located alternately on the upper and lower surfaces of the layers. An alternative structural model, consisting of double layers of tilted straight alkyl chains (see figure 5, right), might also be selected to explain the lamellar thicknesses observed. However, this model is not plausible, for it involves an excessively large tilt angle, equal to  $\cos^{-1}(1/2) = 60^\circ$ , seldom, if ever, met in the literature for long chain paraffinic compounds. It is useful to point out here that, whatever the structural model used, the  $\text{N}\equiv\text{C}-\text{C}_3-\text{C}_n$ -DMABr molecules in the crystal have all to be paired through their cyano end-groups which, being strongly dipolar, tend to associate antiferroelectrically with one another [6].

To check the single-layered model, it is useful to calculate the area,  $S$  covered by each pair of molecules in the crystalline layers. This was done in the particular case of  $\text{N}\equiv\text{C}-\text{C}_3-\text{C}_{18}$ -DMABr, whose specific volume was

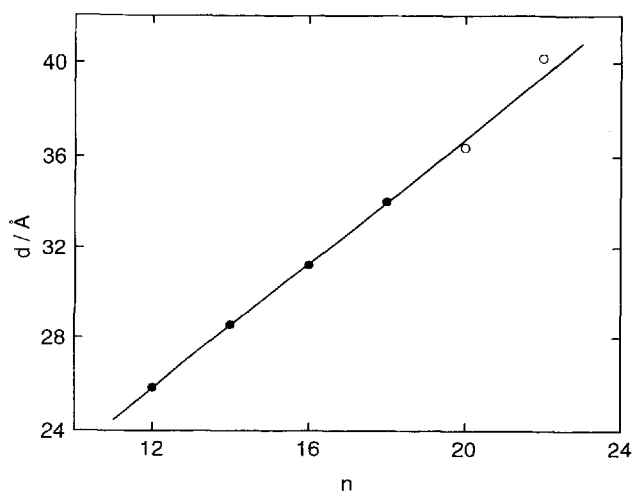

Figure 4. Lamellar spacing of the crystalline  $\text{N}\equiv\text{C}-\text{C}_3-\text{C}_n$ -DMABr at  $30^\circ\text{C}$  as a function of the number ( $n$ ) of carbon atoms in the alkyl chains. For compounds  $n = 20$  and  $22$  (open circles), whose purity is not quite satisfactory, values are only indicative.

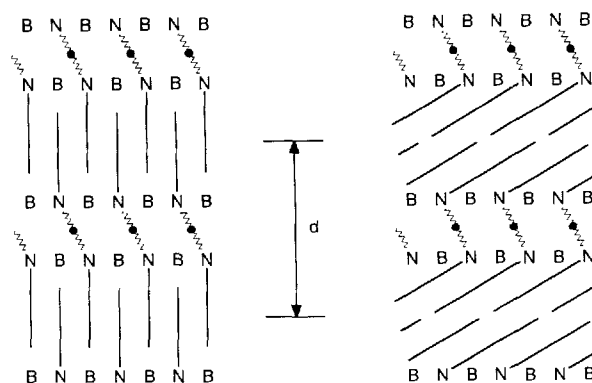

Figure 5. Structural models for  $\text{N}\equiv\text{C}-\text{C}_3-\text{C}_n$ -DMABr in the crystalline state. Alkyl chains are represented by straight lines, cyanopropyl groups by zigzag lines, and coupled cyano groups by dots. N and B stand for ammonium and bromide ions.

determined by dilatometry ( $v = 0.883 \text{ cm}^3 \text{ g}^{-1}$  at  $30^\circ\text{C}$ ). For simple geometrical reasons, the molecular area  $S$  may be taken as equal to the ratio  $2V/d$ , where  $d$  ( $= 34.0 \text{ \AA}$ ) is the lamellar period and  $V$  ( $= Mv = 445.57 \times 0.883 = 393.4 \text{ cm}^3 \text{ mol}^{-1} = 653 \text{ \AA}^3$ ) the volume of one molecule. Significantly close to that ( $\sim 2 \times 18.5 \text{ \AA}^2$ ) of the cross-sectional area of linear paraffin molecules in the crystalline state [10], the value found,  $S = 38.4 \pm 0.2 \text{ \AA}^2$ , constitutes an argument in favour of the structural model presented above, with the alkyl chains standing upright in single layers.

Figure 4 shows the linear dependence of the stacking period of the layers on the number of carbon atoms in the alkyl chains. A least-squares linear fit of the measured values of  $d$  versus  $n$  (in the range  $12 \leq n \leq 18$ ) leads to  $d(\text{\AA}) = 9.50 + 1.362n$  with a reliability factor of 99.99 per cent. The standard deviations are  $0.19 \text{ \AA}$  for the  $Y$  intercept and  $0.013 \text{ \AA}$  for the slope of the corresponding straight line. Note that the lamellar spacings of the  $n = 20$  and  $22$  compounds, whose purity is not quite satisfactory, are nevertheless consistent with this equation.

Clearly, the slope of the straight line depends directly on the molecular area  $S$ . Indeed, as already mentioned above, the volume of a pair of molecules is equal to the product  $Sd$ . With the reasonable assumption of additivity of the partial molar volumes of the constituent parts of the molecules, thoroughly verified in common practice, this may also be taken (with an accuracy of about 1 per cent) as equal to  $2[V_0 + (n-1)V_{\text{CH}_2}]$ , where  $V_{\text{CH}_2}$  and  $V_0$  represent, respectively, the volumes of one methylene group in the alkyl chain and of one molecule totally deprived of its methylene groups, i.e., of one cyanopropyl(trimethylammonium) bromide molecule. The lamellar period may thus be written as

$$d = 2 \frac{V_0 - V_{\text{CH}_2}}{S} + 2 \frac{V_{\text{CH}_2}}{S} n.$$

Table 4. Intensity of Bragg reflections at reciprocal spacing  $s$ , measured for the compounds the  $n$  values indicated in the crystalline structure.

$s/\text{\AA}^{-1}$	$I(n=12)$	$I(n=14)$	$I(n=16)$	$I(n=18)$	$I(n=20)$	$I(n=22)$
0.0506	—	—	—	—	—	556
0.0544	—	—	—	—	803	—
0.0588	—	—	—	281	—	—
0.0640	—	—	513	—	—	—
0.0700	—	273	—	—	—	—
0.0753	—	—	—	—	—	0
0.0774	0	—	—	—	—	—
0.0816	—	—	—	—	0	—
0.0882	—	—	—	0	—	—
0.0960	—	—	297	—	—	—
0.1012	—	—	—	—	—	350
0.1050	—	395	—	—	—	—
0.1088	—	—	—	—	419	—
0.1161	456	—	—	—	—	—

The packing of the ammonium end-groups in the crystalline layers being the same for all the homologues and the molecular area  $S$  being, therefore, a constant, this equation represents a straight line. From the measured slope of the straight line,  $2V_{\text{CH}_2}/S = 1.362 \pm 0.013 \text{\AA}$ , and using for  $V_{\text{CH}_2}$  a value of about  $25 \pm 1 \text{\AA}^3$  [11], we immediately obtain for the molecular area of a pair of molecules the value of  $37 \pm 1.5 \text{\AA}^2$ . This is in compliance with the value determined previously for the  $n = 18$  compound using dilatometry and also in perfect agreement with the known value of the cross-sectional area of two paraffin molecules.

From the  $Y$ -intercept of the straight line,  $2(V_0 - V_{\text{CH}_2})/S = 9.50 \pm 0.19 \text{\AA}$  and from the values of  $S = 37 \pm 1.5 \text{\AA}^2$  and  $V_{\text{CH}_2} = 25 \pm 1 \text{\AA}^3$  given above, we may now estimate the volume of one cyanopropyl(trimethylammonium) bromide molecule,  $V_0 = 201 \pm 15 \text{\AA}^3$ . This turns out reasonably to be larger than the volume of one tetramethylammonium bromide molecule in the crystalline state ( $162 \text{\AA}^3$ ) [12]. The thickness of the sub-layer formed by the polar head-groups of the molecules, approximated by the lamellar spacing of the  $n = 1$  compound ( $10.9 \pm 0.2 \text{\AA}$ ), is in addition consistent with the size of a tetramethylammonium cation ( $6.9 \text{\AA}$ ) and a bromide anion ( $3.9 \text{\AA}$ ) superposed [1].

Inspection of table 3 shows that the intensities of the lamellar reflections do not vary monotonically as a function of the Bragg angle, contrary to what should be the case if the heavy bromide ions in each crystalline layer were all located in the same thin plane. Incidentally, this was the case for the smectic T mesophase of the dialkyldimethylammonium bromide compounds already reported [1]. Instead, the intensity oscillates, going through a minimum value of zero at a given Bragg angle. As clearly seen in table 4, the intensity vanishes for reflections located at Bragg spacings in the range from  $0.075$  to  $0.090 \text{\AA}^{-1}$ . This means that the bromide ions in

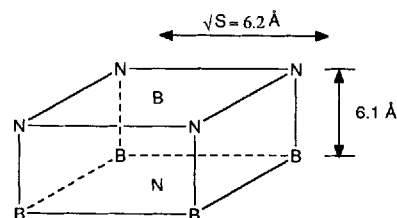

Figure 6. Schematic view of the arrangement of the ammonium (N) and bromide (B) ions in two tetragonal two dimensional lattices superposed at a distance of  $6.1 \text{\AA}$ .

each layer are not confined to single planes, but are quite likely to be located in two distinct planes separated by a short distance,  $a$ , larger than their electron density diameter. From the position of the minimum in the intensity distribution curve,  $s_{\text{min}} \cong 0.0825 \text{\AA}^{-1}$ , we may deduce [13] the value of  $a \cong 6.1 \text{\AA}$ , which is in compliance with the thickness of the head-group sub-layers ( $10.9 \text{\AA}$ ) and the diameter of the bromide ions ( $3.9 \text{\AA}$ ). With the reasonable assumption that in each ionic plane the ammonium and bromide ions are arranged as in the case of the tetragonal smectic phase [1], we may deduce that the structure of the polar sub-layer (see figure 6) results from the superposition of two ionic planes at a distance of  $6.1 \text{\AA}$ , shifted along a semi-diagonal of the tetragonal net so as to let the ions of opposite charge face one another, as expected from electrostatics.

## 5. Smectic structure

The smectic A character of the  $\text{N}\equiv\text{C}-\text{C}_3-\text{C}_n-\text{DMABr}$  compounds at high temperature, suggested by the optical textures observed, was checked and analysed by X-ray diffraction. The X-ray patterns registered contain, indeed, one sharp reflection in the small-angle region, related to the smectic period, and a diffuse band in the wide-angle

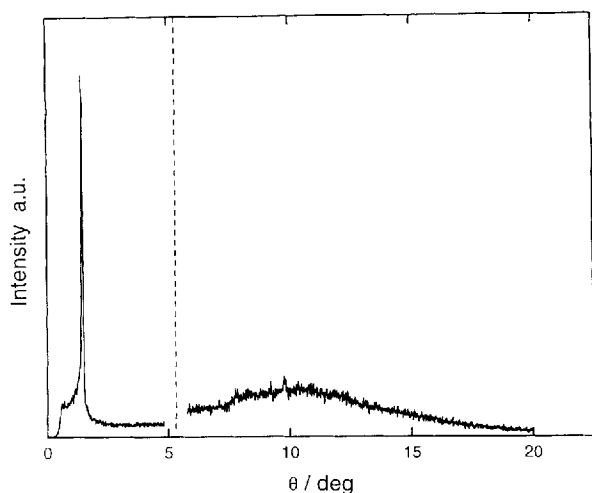

Figure 7. X-ray powder diffraction pattern of  $\text{N}\equiv\text{C}-\text{C}_3-\text{C}_{14}$ -DMABr in the smectic state, recorded at  $90^\circ\text{C}$  with a curved position-sensitive detector as a function of the Bragg angle  $\theta$  ( $2d \sin \theta = n\lambda$ ). For clarity, small and wide-angle regions are represented separately; intensity in the wide-angle region is doubled for convenience.

region at about  $4.5 \text{ \AA}$ , characteristic of the disordered arrangement of the molecules within the layers (see figure 7).

The smectic periods measured decrease slightly, but measurably, as a function of increasing temperature, with a relative expansion coefficient of the layer thickness,  $(\partial d/\partial T)/d$ , of about  $-6 \times 10^{-4} \text{ K}^{-1}$ . Clearly, the molecular area, related to the lateral expansion of the layers, grows more than just that expected from the overall volume expansion of the system, in accordance with what is usually observed with smectic A liquid crystals, where the polar parts of the molecules are arranged in a liquid-like fashion and hence are free to move relative to one another. An additional argument in favour of the variability of the molecular area is given by the fact, shown in figure 8, that the smectic periods do not grow linearly with the number of carbon atoms in the alkyl chains, as for the crystal. It is of interest to recall here the main characteristic of the smectic structure observed with the dialkyldimethylammonium bromides [1], i.e. the orderly and dense arrangement of the ions in the smectic layers. The liquid-like packing of the ions in the present work has of course been induced by the presence of the cyano groups at the ends of the propyl chains and by the geometrical constraints imposed on the system by their antiparallel coupling.

To get some information about the molecular arrangement in the smectic phase, it is useful to calculate the area  $S$  covered by a pair of molecules in the layers. This was done for the octadecyl derivative, whose specific volume was determined by dilatometry ( $v = 0.983 \text{ cm}^3 \text{ g}^{-1}$  at  $90^\circ\text{C}$ ). The value found,  $S = 2V/d = 39.2 \text{ \AA}^2$ , is only

slightly larger than in the crystal, indicating that, in spite of their disordered arrangement, the ionic end-groups are held together, practically in close contact, by strong electrical attractions.

To calculate the molecular area from the smectic periods measured—which, as already seen, do not depend linearly on the length of the alkyl chains—we proceeded directly using the following obvious equations:

$$S = 2V/d$$

and

$$V(n) = V(18) + (n - 18)V_{\text{CH}_2}$$

where  $V(18) = 728 \text{ \AA}^3$  and  $V_{\text{CH}_2} = 27.8 \text{ \AA}^3$  at  $90^\circ\text{C}$  [13]. Figure 9 shows that the molecular area increases slowly with  $n$ , starting from about  $37 \text{ \AA}^2$  for  $n = 12$  and levelling off at about  $39 \text{ \AA}^2$  for  $n > 16$ .

As the averaged cross-sectional area of each alkyl chain in a disordered conformation must appreciably exceed the value which characterizes the close packing of the crystal ( $\sim 18.5 \text{ \AA}^2$ ), it is quite clear that the alkyl chains in the smectic structure must be arranged in double rather than in single layers as in the crystal (see figure 10). The transition from the crystal to the smectic mesophase corresponds, therefore, to the melting of the alkyl chains and to their ordering in double, instead of single, layers. Incidentally, this is why the lamellar spacings observed in the smectic phase are systematically larger (by as much as a few Ångström units) than in the crystal form.

Finally, it is useful to comment on the presence in the X-ray patterns of only one sharp reflection related to the smectic ordering, instead of many harmonics as observed in the case of the crystal. This is merely due to the combination of two independent effects. The first is the

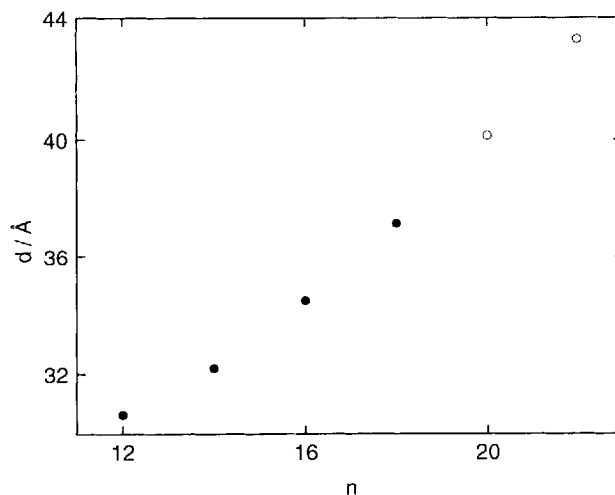

Figure 8. Smectic period of  $\text{N}\equiv\text{C}-\text{C}_3-\text{C}_n$ -DMABr at  $90^\circ$  as a function of number ( $n$ ) of carbon atoms in the alkyl chains. For compounds  $n = 20$  and  $22$  (open circles), whose purity is not quite satisfactory, values are only indicative.

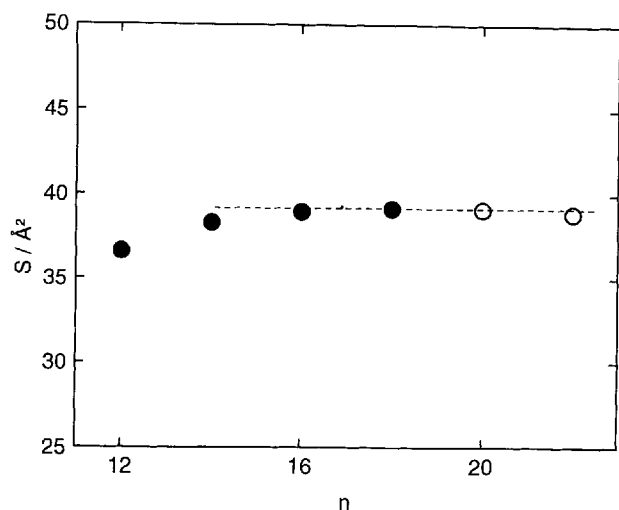

Figure 9. Molecular area of  $\text{N}\equiv\text{C}-\text{C}_3-\text{C}_n-\text{DMABr}$  at  $90^\circ$  as a function of number ( $n$ ) of carbon atoms in the alkyl chains. For compounds  $n = 20$  and  $22$  (open circles), whose purity is not quite satisfactory, values are only indicative.

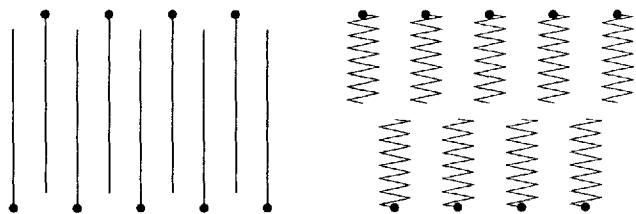

Figure 10. Schematic view of a single-layered arrangement of fully extended interdigitated alkyl chains in the crystalline layers (left) and of a double-layered arrangement of disordered alkyl chains in the smectic layers (right).

increased overall thickness of the 'polar' sub-layers, suggested by the upward curvature of the  $d$  line versus  $n$ , causing a narrowing of the intensity distribution in reciprocal Bragg space. The second is the enhanced Debye-Waller effect which, made easier by the disordered nature of the smectic phase and amplified by the high-temperatures experienced, causes an important attenuation of the high Bragg harmonics. It is helpful to note in this connection that small random displacements of the bromide ions are sufficient to cause an overlap of their electron density distribution along the layer normal and thus to produce a considerable apparent thickening of the diffracting sub-layers.

This work was carried out within the framework of the 'Plato' bilateral co-operation programme between France and Greece.

### References

- [1] ALAMI, E., LEVY, H., ZANA, R., WEBER, P., and SKOULIOS, A., 1993, *Liq. Crystals*, **13**, 201.
- [2] PALEOS, C. M., and TSIOURVAS, D., *Angew. Chem. Inter. Ed.* (in the press).
- [3] IWAMOTO, K., OHNUKI, K., SAWADA, K., and SENO, M., 1981, *Molec. Crystals liq. Crystals*, **73**, 95
- [4] MALLIARIS, A., CHRISTIAS, C., MARGOMENOU-LEONIDOPOULOU, G., and PALEOS, C. M., 1982, *Molec. Crystals liq. Crystals*, **82**, 161.
- [5] PALEOS, C. M., 1994, *Molec. Crystals liq. Crystals*, **243**, 159.
- [6] BARBARIN, F., PIOVESAN, A., GUILLON, D., and SKOULIOS, A., 1988, *J. Phys., Paris*, **49**, 1583. FADEL, H., GUILLON, D., SKOULIOS, A., BARBARIN, F., and DUGAY, M., 1989, *J. Phys., Paris*, **50**, 375.
- [7] GOERDLER, J., 1958, *Methoden der organischen Chemie*, edited by Houben and Weyl (Georg Thieme Verlag).
- [8] HEINRICH, B., GUILLON, D., and SKOULIOS, A. (in preparation).
- [9] Taking into account the fact that the geometry of the nitrogen atom of the ammonium group has the same tetrahedral symmetry and approximately the same size as the tetravalent carbon atoms in the alkyl chains, and that the length of one zigzag of carbon atoms in a paraffin chain is roughly  $2.54 \text{ \AA}$ , the length of a  $\text{N}\equiv\text{C}-\text{C}_3-\text{C}_n-\text{DMABr}$  molecule in a fully extended conformation may be approximately to by  $L = 2.54(n + 5)/2 + 4 \text{ \AA}$ . The number 4 in this equation represents the van der Waals diameter of one terminal endgroup.
- [10] ROBERTSON, J. M., 1953, *Organic Crystals and Molecules* (Cornell University Press).
- [11] Estimated from the crystal structure of the B form of stearic acid: see VON SYDOW, E., 1985, *Acta crystallogr.*, **8**, 557.
- [12] *Handbook of Chemistry and Physics*, 56th edition (CRC Press).
- [13] The intensity distribution curve for a lamellar structure  $I(s) \propto F^2(s)$ , where the structure factor  $F(s)$  is the Fourier transform of the electron density distribution along the layer normal. With the heavy bromine atoms located in two distinct planes at  $r = \pm a/2$  with respect to the mid-plane of each lamellum, the electron density distribution can be written as  $\rho(r) \propto \delta(r - a/2) + \delta(r + a/2)$ . Hence, the structure factor is  $F(s) \propto \cos(\pi as)$ , and the intensity  $I(s) \propto \cos^2(\pi as)$ . The minimum of the intensity curve is at  $s = 1/2a$ .
- [14] BENATTAR, J. J., GUILLON, D., and SKOULIOS, A., 1986, *J. Phys., Paris*, **47**, 133.